

**NPN Silicon AF Transistors**

- For AF driver and output stages
- High collector current
- Low collector-emitter saturation voltage
- Complementary types: BCP51...BCP53 (PNP)
- Pb-free (RoHS compliant) package<sup>1)</sup>
- Qualified according AEC Q101

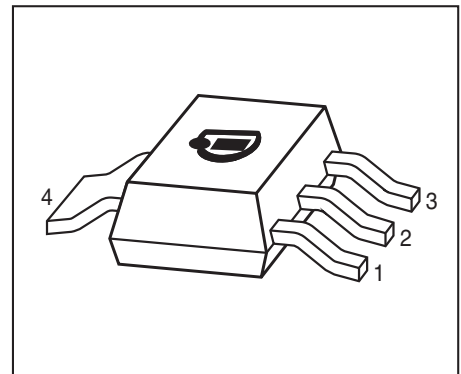

Type	Marking	Pin Configuration						Package
		1=B	2=C	3=E	4=C	-	-	
BCP54	*	1=B	2=C	3=E	4=C	-	-	SOT223
BCP54-16	*	1=B	2=C	3=E	4=C	-	-	SOT223
BCP55	*	1=B	2=C	3=E	4=C	-	-	SOT223
BCP55-16	*	1=B	2=C	3=E	4=C	-	-	SOT223
BCP56-10	*	1=B	2=C	3=E	4=C	-	-	SOT223
BCP56-16	*	1=B	2=C	3=E	4=C	-	-	SOT223

\* Marking is the same as the type-name

<sup>1)</sup>Pb-containing package may be available upon special request

**Maximum Ratings**

Parameter	Symbol	Value	Unit
Collector-emitter voltage	$V_{CEO}$	45 60 80	V
BCP54			
BCP55			
BCP56			
Collector-emitter voltage	$V_{CER}$	45 60 100	
BCP54			
BCP55			
BCP56			
Collector-base voltage	$V_{CBO}$	45 60 100	
BCP54			
BCP55			
BCP56			
Emitter-base voltage	$V_{EBO}$	5	
Collector current	$I_C$	1	A
Peak collector current, $t_p \leq 10$ ms	$I_{CM}$	1.5	
Base current	$I_B$	100	mA
Peak base current	$I_{BM}$	200	
Total power dissipation- $T_S \leq 120^\circ\text{C}$	$P_{tot}$	2	W
Junction temperature	$T_j$	150	°C
Storage temperature	$T_{stg}$	-65 ... 150	

**Thermal Resistance**

Parameter	Symbol	Value	Unit
Junction - soldering point <sup>1)</sup>	$R_{thJS}$	$\leq 15$	K/W

<sup>1)</sup>For calculation of  $R_{thJA}$  please refer to Application Note Thermal Resistance

**Electrical Characteristics at  $T_A = 25^\circ\text{C}$ , unless otherwise specified**

Parameter	Symbol	Values			Unit
		min.	typ.	max.	
<b>DC Characteristics</b>					
Collector-emitter breakdown voltage $I_C = 10\text{ mA}$ , $I_B = 0$ , BCP54... $I_C = 10\text{ mA}$ , $I_B = 0$ , BCP55... $I_C = 10\text{ mA}$ , $I_B = 0$ , BCP56-10, -16	$V_{(BR)CEO}$	45 60 80	- - -	- - -	V
Collector-base breakdown voltage $I_C = 100\text{ }\mu\text{A}$ , $I_E = 0$ , BCP54... $I_C = 100\text{ }\mu\text{A}$ , $I_E = 0$ , BCP55... $I_C = 100\text{ }\mu\text{A}$ , $I_E = 0$ , BCP56-10, -16	$V_{(BR)CBO}$	45 60 100	- - -	- - -	
Emitter-base breakdown voltage $I_E = 10\text{ }\mu\text{A}$ , $I_C = 0$	$V_{(BR)EBO}$	5	-	-	
Collector-base cutoff current $V_{CB} = 30\text{ V}$ , $I_E = 0$ $V_{CB} = 30\text{ V}$ , $I_E = 0$ , $T_A = 150\text{ }^\circ\text{C}$	$I_{CBO}$	- -	- -	0.1 20	$\mu\text{A}$
DC current gain <sup>1)</sup> $I_C = 5\text{ mA}$ , $V_{CE} = 2\text{ V}$ $I_C = 150\text{ mA}$ , $V_{CE} = 2\text{ V}$ , BCP54/BCP55 $I_C = 150\text{ mA}$ , $V_{CE} = 2\text{ V}$ , BCP56-10 $I_C = 150\text{ mA}$ , $V_{CE} = 2\text{ V}$ , BCP54-16...BCP56-16 $I_C = 500\text{ mA}$ , $V_{CE} = 2\text{ V}$	$h_{FE}$	25 40 63 100 25	- - 100 160 -	- 250 160 250 -	-
Collector-emitter saturation voltage <sup>1)</sup> $I_C = 500\text{ mA}$ , $I_B = 50\text{ mA}$	$V_{CEsat}$	-	-	0.5	V
Base-emitter voltage <sup>1)</sup> $I_C = 500\text{ mA}$ , $V_{CE} = 2\text{ V}$	$V_{BE(ON)}$	-	-	1	
<b>AC Characteristics</b>					
Transition frequency $I_C = 50\text{ mA}$ , $V_{CE} = 10\text{ V}$ , $f = 100\text{ MHz}$	$f_T$	-	100	-	MHz

<sup>1)</sup>Pulse test:  $t < 300\mu\text{s}$ ;  $D < 2\%$

**DC current gain  $h_{FE} = f(I_C)$**

$V_{CE} = 2\text{ V}$

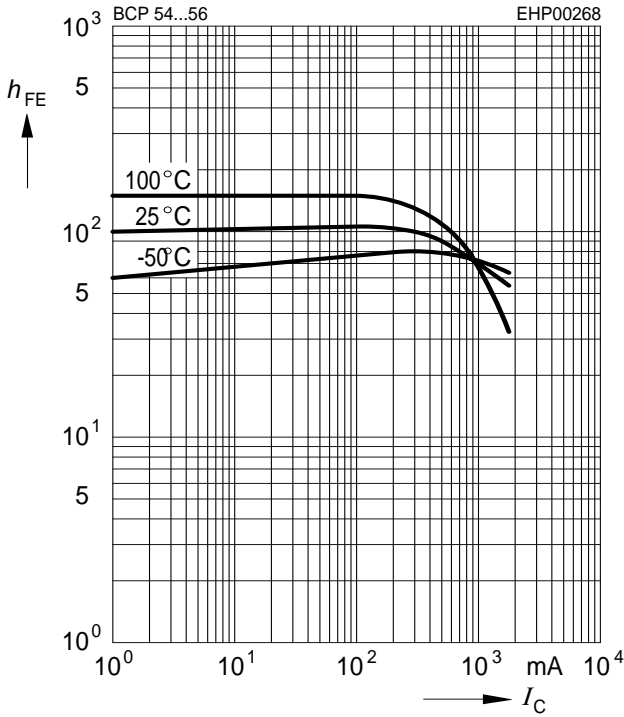

**Collector-emitter saturation voltage**

$I_C = f(V_{CEsat}), h_{FE} = 10$

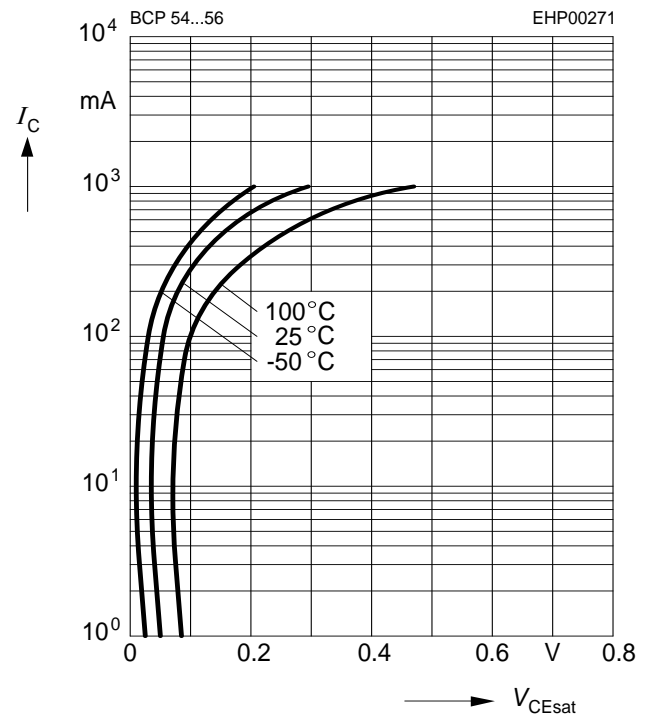

**Base-emitter saturation voltage**

$I_C = f(V_{BEsat}), h_{FE} = 10$

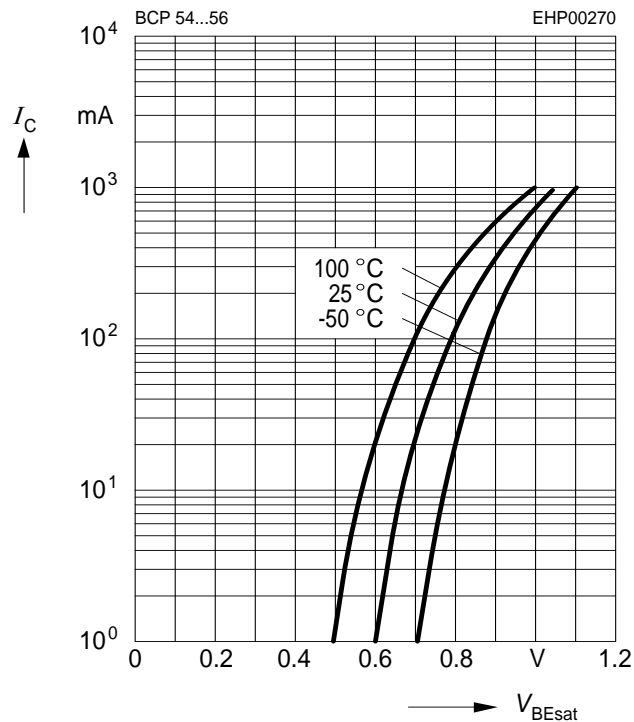

**Collector cutoff current  $I_{CBO} = f(T_A)$**

$V_{CBO} = 30\text{ V}$

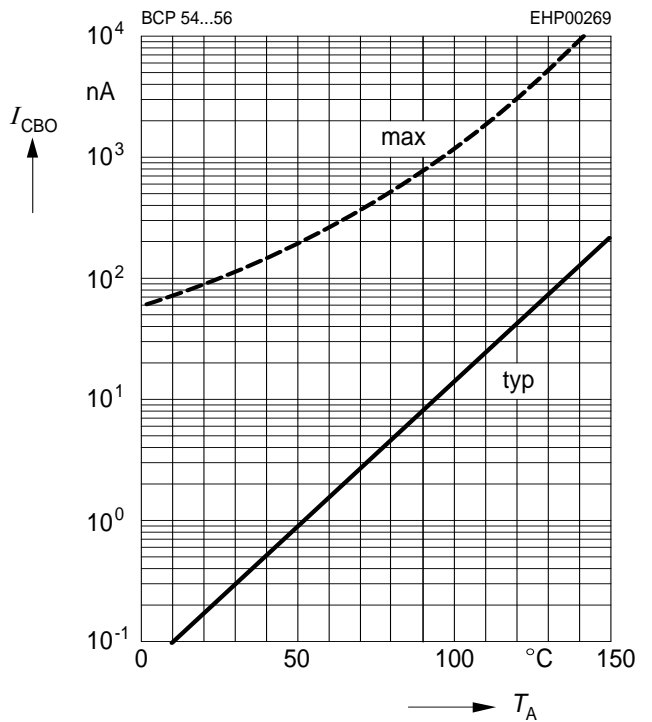

Transition frequency  $f_T = f(I_C)$

$V_{CE} = 10\text{ V}$

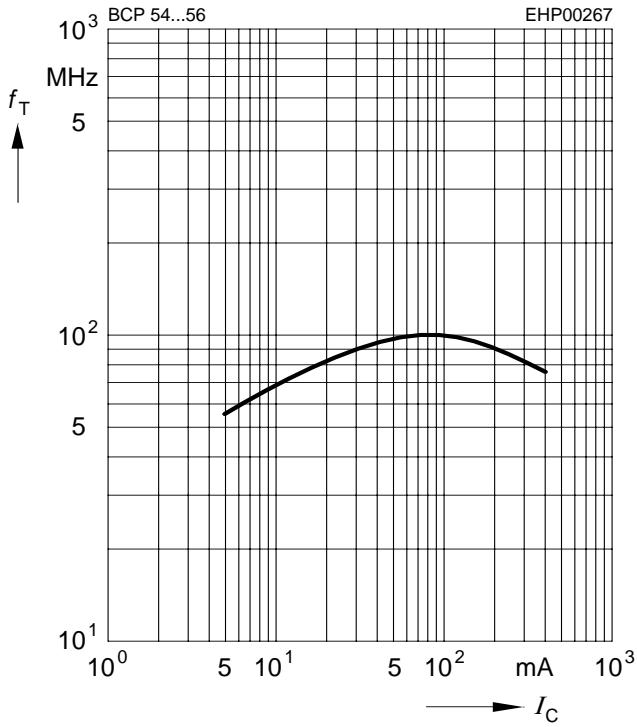

Total power dissipation  $P_{tot} = f(T_S)$

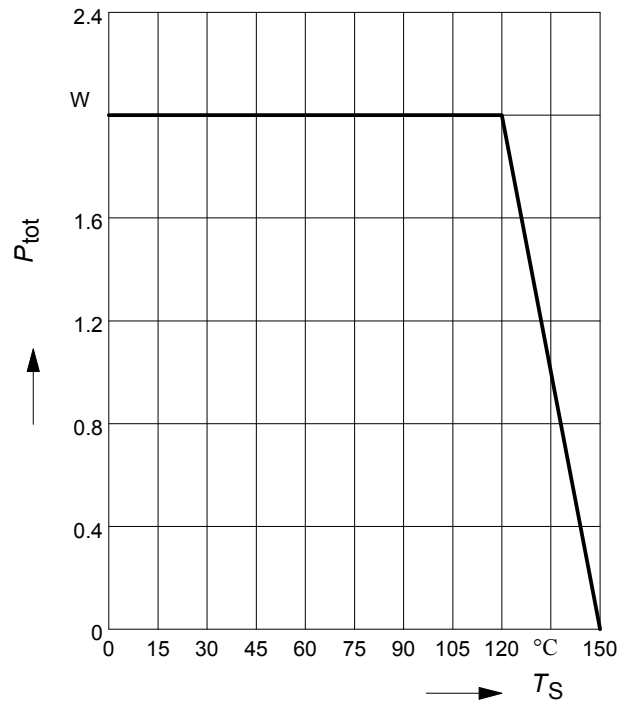

Permissible Pulse Load  $R_{thJS} = f(t_p)$

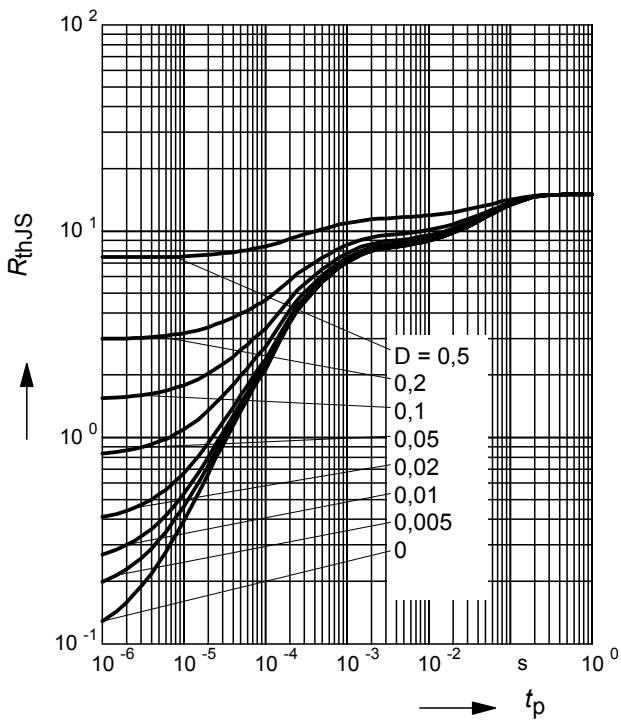

Permissible Pulse Load

$P_{totmax}/P_{totDC} = f(t_p)$

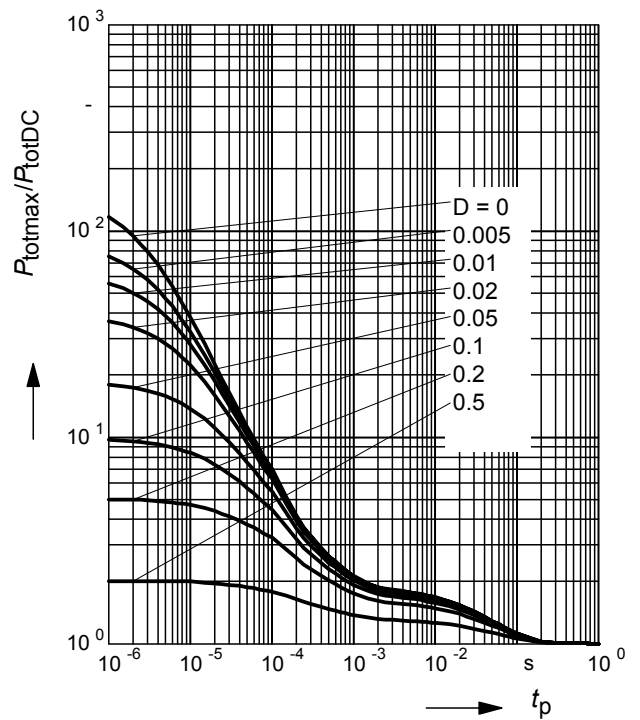

### Package Outline

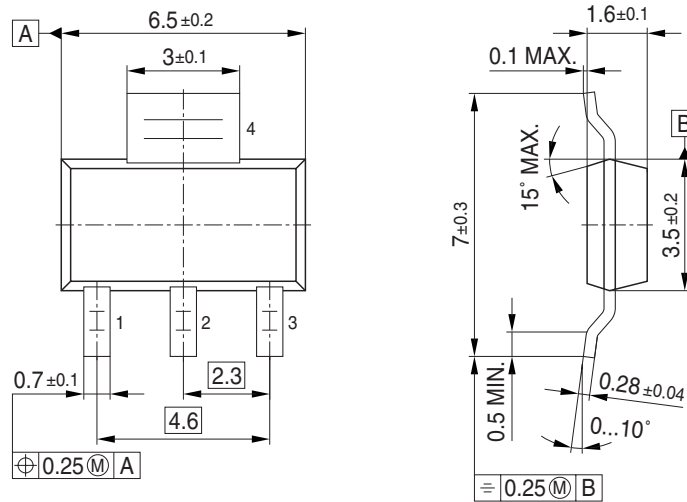

### Foot Print

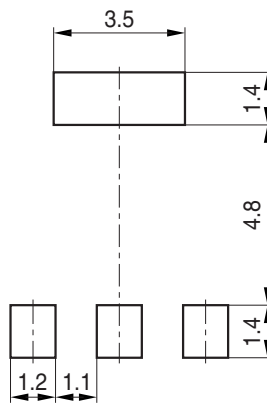

### Marking Layout (Example)

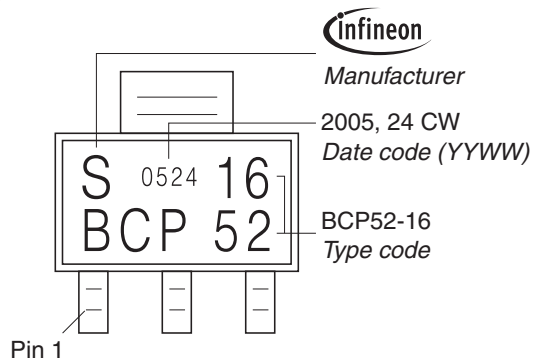

### Packing

Reel  $\varnothing 180$  mm = 1.000 Pieces/Reel  
 Reel  $\varnothing 330$  mm = 4.000 Pieces/Reel

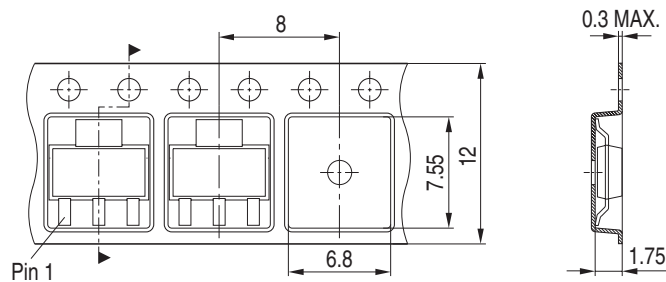

Edition 2006-02-01

Published by

Infineon Technologies AG

81726 München, Germany

© Infineon Technologies AG 2007.

All Rights Reserved.

### **Attention please!**

The information given in this dokument shall in no event be regarded as a guarantee of conditions or characteristics ("Beschaffenheitsgarantie"). With respect to any examples or hints given herein, any typical values stated herein and/or any information regarding the application of the device, Infineon Technologies hereby disclaims any and all warranties and liabilities of any kind, including without limitation warranties of non-infringement of intellectual property rights of any third party.

### **Information**

For further information on technology, delivery terms and conditions and prices please contact your nearest Infineon Technologies Office ([www.infineon.com](http://www.infineon.com)).

### **Warnings**

Due to technical requirements components may contain dangerous substances. For information on the types in question please contact your nearest Infineon Technologies Office.

Infineon Technologies Components may only be used in life-support devices or systems with the express written approval of Infineon Technologies, if a failure of such components can reasonably be expected to cause the failure of that life-support device or system, or to affect the safety or effectiveness of that device or system.

Life support devices or systems are intended to be implanted in the human body, or to support and/or maintain and sustain and/or protect human life. If they fail, it is reasonable to assume that the health of the user or other persons may be endangered.